

The PT5E encoder-based cable-extension transducer offers a unique thermoplastic cable that has virtually an infinite fatigue life. This cable, known as V62, has properties that are superior for high cycle and rugged applications.

Like our other transducers, the PT5E installs in minutes, functions properly without perfectly parallel alignment, and fits easily into small areas. The PT5E offers additional installation flexibility since its cable exit can be rotated relative to the mounting surface, providing four different cable exit orientations.

PT5E

Cable Actuated Sensor

Industrial Grade • Incremental Encoder

Absolute Linear Position to 250 inches (6350 mm)

Hard Anodized Aluminum Enclosure

High Cycle Applications

IP67 • NEMA 6 Protection

GENERAL

Full Stroke Range Options	0-50 to 0-250 inches
Output Signal Options	incremental encoder (quadrature)
Accuracy	.04% to .1% f.s. – see ordering info
Repeatability	.01% to .02% f.s. – see ordering info
Resolution	10 to 250 pulses per inch
Measuring Cable Options	stainless steel or thermoplastic
Enclosure Material	hard anodized aluminum
Sensor	optical encoder
Max Measuring Cable Velocity	see ordering information
Max Retraction Acceleration	see ordering information
Weight	5 lbs. max.

ELECTRICAL

Input Voltage	see ordering information
Input Current	see ordering information

ENVIRONMENTAL

Enclosure	NEMA 4/6, IP 65/67
Operating Temperature	0° to 160°F (-17° to 71°C)
Vibration	up to 10 g to 2000 Hz maximum

Output Signal

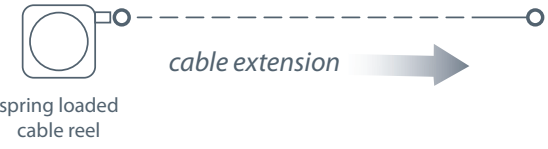
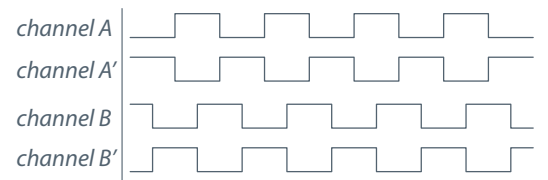

-- see ordering information for available channels

Outline Drawing:

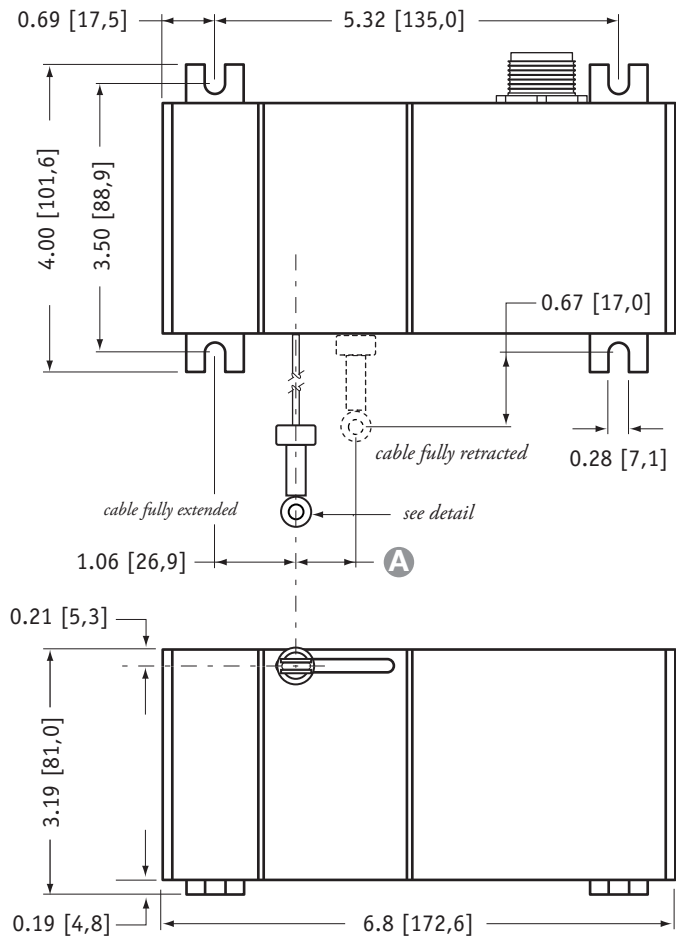

A DIMENSION (inches[mm])		
RANGE	N34 measuring cable	S47 & V62 measuring cable
50	0.23 [5,9]	0.39 [9,9]
100	0.46 [11,7]	0.78 [19,7]
150	0.69 [17,6]	1.16 [29,6]
200	0.92 [23,5]	n/a
250	1.16 [29,3]	n/a

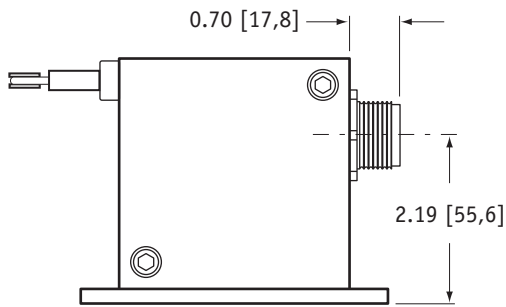
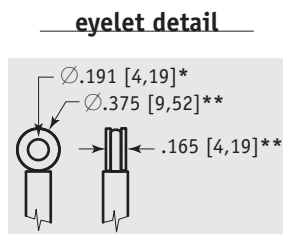

DIMENSIONS ARE IN INCHES [MM]
tolerances are 0.03 IN. [0.5 MM] unless otherwise noted.

* tolerance = +.005 -.001 [+.13 -.03]
** tolerance = +.005 -.005 [+.13 -.13]

Ordering Information:

Model Number:



Sample Model Number:

PT5E - 100 - N34 - FR - 100 - AB-TTL - M6

- R** range: 100 inches
- A** measuring cable: .034 nylon-coated stainless front
- B** cable exit: front
- C** resolution: 100±2 pulses per inch
- D** output signal: TTL/CMOS compatible driver
- E** electrical connection: 6-pin plastic connector

Full Stroke Range:

R order code:	50	100	150	200	250	1250	2500	3750	5000	6250
full stroke range, min:	50 in.	100 in.	150 in.	200 in.	250 in.	1250 mm	2500 mm	3750 mm	5000 mm	6250 mm
△ accuracy (± % of f.s.):	.1	.07	.06	.05	.04	.1	.07	.06	.05	.04
repeatability (± % of f.s.):	.02	.01	.01	.01	.01	.02	.01	.01	.01	.01
cable tension (±20%):	41 ounces			21 ounces			11,4 N		5,8 N	
cable velocity • acceleration:	300 in./sec • 5 g			120 in./sec • 2 g			8 M/sec • 5 g		3 M/sec • 2 g	

Ordering Information (cont.):

Measuring Cable:

A order code:

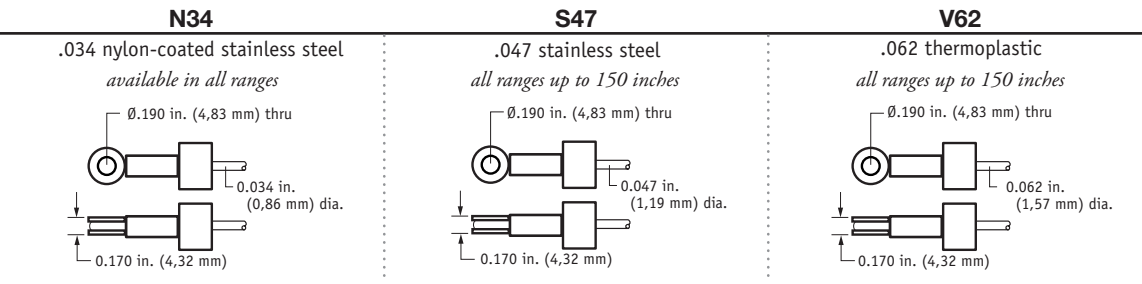

Cable Exit:

B order code:

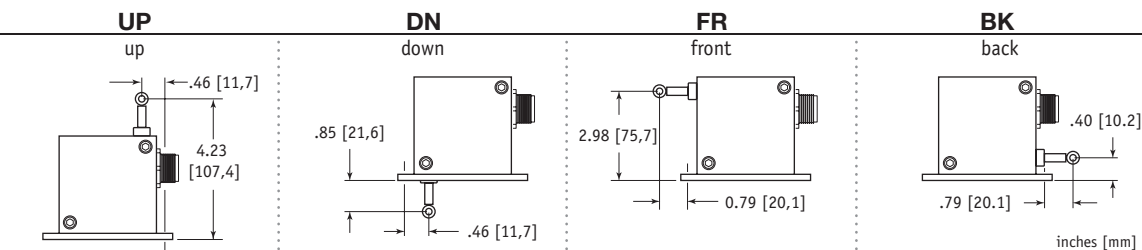

Resolution:

C order code:

	10	100	200	250
resolution for english ranges:	10 ±0.2 pulses per inch	100 ±2 pulses per inch	200 ±4 pulses per inch	250 ±5 pulses per inch

D order code:

	.5	5	10	12.5
resolution for metric ranges:	0.5 ±0.01 pulses per mm	5 ±0.1 pulses per mm	10 ±0.2 pulses per mm	12.5 ±0.3 pulses per mm

Output Signals:



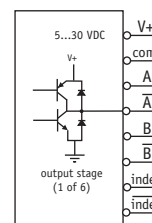
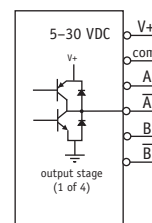
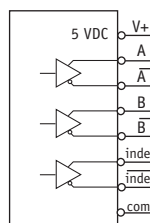
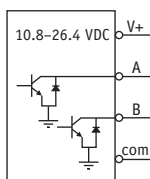
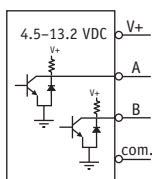

E order code:

	AB-TTL	AB-OC	ABC-LD	ABC-UD	ABZCUD
output driver:	TTL/CMOS compatible	open collector	5-volt line driver	universal line driver <i>(no index)</i>	universal line driver <i>(with index)</i>
input voltage:	4.5...13.2 VDC	10.8...26.4 VDC	5 VDC	5...30 VDC	5...30 VDC
max. source/sink current:	20 mA sink	20 mA sink	20 mA sink	20 mA source/sink	20 mA source/sink
max. input current:	80 mA	80 mA	150 mA	100 mA, no load	100 mA, no load

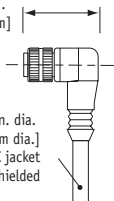
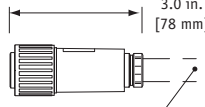
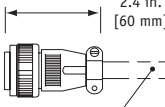
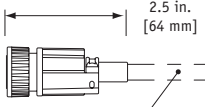

Ordering Information (cont.):

Electrical Connection:

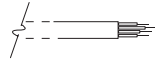
order code:	MC4	M6	M6M	M18	C25																																																						
	4-pin micro-connector with 12 ft [3.5 M] cord set IP 67, NEMA 6	6-pin plastic connector with mating plug IP 67, NEMA 6	6-pin metal connector with mating plug IP 65, NEMA 4	18-pin plastic connector with mating plug IP 67, NEMA 6	25-ft. instrumentation cable 24 AWG, shielded IP 67, NEMA 6																																																						
	1.2 in. [31 mm]	3.0 in. [78 mm]	2.4 in. [60 mm]	2.5 in. [64 mm]																																																							
																																																											
	12 ft. x 5/16-in. dia. [3,5 M x 8 mm dia.] yellow PVC jacket 22AWG, shielded	.30 - .39 in. [8 - 10 mm] cable dia. 16 AWG max conductor size connector: MS3102E-14S-6P mating plug: MS3106E-14S-6S	.375 in. [9 mm] max cable dia. 16 AWG max conductor size connector: MS3102E-14S-6P mating plug: MS3106E-14S-6S	.26 - .30 in. [7 - 8 mm] cable dia. 20 - 24 AWG conductor size connector: Conxall 14282-18PG-300-K mating plug: Conxall 13282-18SG-326-K	25 ft. x 0.2-in. dia. [7,5 M x 5 mm dia.] 24 AWG, shielded																																																						
4-pin cordset:			6-pin mating plug:																																																								
 <table border="1"> <thead> <tr> <th>pin</th> <th>color code</th> <th>TTL/CMOS</th> <th>5 V Line Driver</th> </tr> </thead> <tbody> <tr> <td>1</td> <td>RED-BLK TR.</td> <td>Open Collector</td> <td>input voltage</td> </tr> <tr> <td>2</td> <td>RED-WHT TR.</td> <td>input voltage</td> <td>channel A</td> </tr> <tr> <td>3</td> <td>RED</td> <td>channel A</td> <td>channel B</td> </tr> <tr> <td>4</td> <td>GREEN</td> <td>channel B</td> <td>common</td> </tr> </tbody> </table>			pin	color code	TTL/CMOS	5 V Line Driver	1	RED-BLK TR.	Open Collector	input voltage	2	RED-WHT TR.	input voltage	channel A	3	RED	channel A	channel B	4	GREEN	channel B	common	 <table border="1"> <thead> <tr> <th>pin</th> <th>TTL/CMOS</th> <th>5 V Line Driver</th> </tr> </thead> <tbody> <tr> <td>A</td> <td>Open Collector</td> <td>input voltage</td> </tr> <tr> <td>B</td> <td>input voltage</td> <td>channel A</td> </tr> <tr> <td>C</td> <td>common</td> <td>channel B</td> </tr> <tr> <td>D</td> <td>channel A</td> <td>channel B</td> </tr> <tr> <td>E</td> <td>channel B</td> <td>channel A'</td> </tr> <tr> <td>F</td> <td>-</td> <td>channel B'</td> </tr> </tbody> </table>			pin	TTL/CMOS	5 V Line Driver	A	Open Collector	input voltage	B	input voltage	channel A	C	common	channel B	D	channel A	channel B	E	channel B	channel A'	F	-	channel B'													
pin	color code	TTL/CMOS	5 V Line Driver																																																								
1	RED-BLK TR.	Open Collector	input voltage																																																								
2	RED-WHT TR.	input voltage	channel A																																																								
3	RED	channel A	channel B																																																								
4	GREEN	channel B	common																																																								
pin	TTL/CMOS	5 V Line Driver																																																									
A	Open Collector	input voltage																																																									
B	input voltage	channel A																																																									
C	common	channel B																																																									
D	channel A	channel B																																																									
E	channel B	channel A'																																																									
F	-	channel B'																																																									
18-pin mating plug:			25-ft. instrumentation cable:																																																								
 <table border="1"> <thead> <tr> <th>pin</th> <th>TTL/CMOS</th> <th>5 V Line Driver</th> </tr> </thead> <tbody> <tr> <td>1</td> <td>Open Collector</td> <td>input voltage</td> </tr> <tr> <td>2</td> <td>input voltage</td> <td>channel B</td> </tr> <tr> <td>3</td> <td>channel B</td> <td>channel A</td> </tr> <tr> <td>6</td> <td>channel A</td> <td>channel A</td> </tr> <tr> <td>7</td> <td>-</td> <td>index</td> </tr> <tr> <td>11</td> <td>-</td> <td>channel B'</td> </tr> <tr> <td>12</td> <td>-</td> <td>channel A'</td> </tr> <tr> <td>15</td> <td>-</td> <td>index'</td> </tr> </tbody> </table>			pin	TTL/CMOS	5 V Line Driver	1	Open Collector	input voltage	2	input voltage	channel B	3	channel B	channel A	6	channel A	channel A	7	-	index	11	-	channel B'	12	-	channel A'	15	-	index'	 <table border="1"> <thead> <tr> <th>color</th> <th>TTL/CMOS</th> <th>5 V Line Driver</th> </tr> </thead> <tbody> <tr> <td>red</td> <td>Open Collector</td> <td>input voltage</td> </tr> <tr> <td>black</td> <td>input voltage</td> <td>channel A</td> </tr> <tr> <td>green</td> <td>common</td> <td>channel B</td> </tr> <tr> <td>white</td> <td>channel A</td> <td>channel A</td> </tr> <tr> <td>blue</td> <td>channel B</td> <td>channel B'</td> </tr> <tr> <td>brown</td> <td>-</td> <td>channel A'</td> </tr> <tr> <td>yellow</td> <td>-</td> <td>index</td> </tr> <tr> <td>orange</td> <td>-</td> <td>index'</td> </tr> </tbody> </table>			color	TTL/CMOS	5 V Line Driver	red	Open Collector	input voltage	black	input voltage	channel A	green	common	channel B	white	channel A	channel A	blue	channel B	channel B'	brown	-	channel A'	yellow	-	index	orange	-	index'
pin	TTL/CMOS	5 V Line Driver																																																									
1	Open Collector	input voltage																																																									
2	input voltage	channel B																																																									
3	channel B	channel A																																																									
6	channel A	channel A																																																									
7	-	index																																																									
11	-	channel B'																																																									
12	-	channel A'																																																									
15	-	index'																																																									
color	TTL/CMOS	5 V Line Driver																																																									
red	Open Collector	input voltage																																																									
black	input voltage	channel A																																																									
green	common	channel B																																																									
white	channel A	channel A																																																									
blue	channel B	channel B'																																																									
brown	-	channel A'																																																									
yellow	-	index																																																									
orange	-	index'																																																									

⚠ Total accuracy includes uncertainty due to resolution and is calculated: $\{ \pm [(\%FS)(FS) + \text{length of 1 pulse}] \}$

Example: Model Number: PT5E-100-N34-FR100-AB-TTL-M6

Full Stroke: 100 inches

Accuracy: $[.07\% (100 \text{ in.}) + 1/100 \text{ in.}] = \pm .08 \text{ inches}$

NORTH AMERICA Measurement Specialties, Inc. a TE Connectivity Company

20630 Plummer Street
Chatsworth, CA 91311
Tel +1-800-423-5483
Tel +1-818-701-2772
Fax +1-800-701-2799

customer@te.com

te.com/sensorsolutions

Measurement Specialties Inc. a TE Connectivity company

Measurement Specialties, TE Connectivity, TE Connectivity (logo) and Every Connection Counts are trademarks. All other logos, products and/or company names referred to herein might be trademarks of their respective owners.

The information given herein, including drawings, illustrations and schematics which are intended for illustration purposes only, is believed to be reliable. However, TE Connectivity makes no warranties as to its accuracy or completeness and disclaims any liability in connection with its use. TE Connectivity's obligations shall only be as set forth in TE Connectivity's Standard Terms and Conditions of Sale for this product and in no case will TE Connectivity be liable for any incidental, indirect or consequential damages arising out of the sale, resale, use or misuse of the product. Users of TE Connectivity products should make their own evaluation to determine the suitability of each such product for the specific application.

© 2016 TE Connectivity Ltd. family of companies All Rights Reserved.